

PARD

Pantera Series

Thermal Imaging Device



User Manual

Important Reminder

1 All PARD products are exclusively designed for civilian use and strictly prohibited for any military purposes.

2 All PARD products are not authorized for export to, including but not limited to Russia, Belarus, Palestine, Israel, Sudan, South Sudan, and other conflict zones.

Scan To Enjoy Privilege



Scan The QR Code To Join Our Membership

- 1 Extend warranty
- 2 Enjoy 1 on 1 expert service
- 3 Get the product experience officer opportunity

Contents

1. Introduction	01
2. Precautions	01
3. Package Contents	02
4. Description & Key Features	02
5. Specifications	03
6. Components	05
7. Installation	06
8. Operation Instruction	11
1) Shortcut Mode	11
2) Menu Mode	14
9. FCC Warning	23

Introduction

Thank you for your continued support and for choosing PARD Pantera Series thermal imaging camera. Please read this manual carefully before using the device for the first time. Please follow the instructions in this manual to avoid any damage caused by improper use and to ensure that your device operates properly.











After reading, please keep this manual in a safe place, for future reference. This manual provides step-by-step instructions on how to use your multi-spectral digital camera and is intended for your reference only.

Please note that PARD reserves the right to update this manual without prior individual notifications. For the latest information and updates, we recommend you to visit our official website. Additionally, PARD reserves the final right of interpretation of this manual.

Precautions

- Please remove the insulating tape on the battery before first use. It is recommended to use a fully charged lithium-ion battery with a rated voltage of 3.7V.
- Please turn off the device and remove the battery when it's not in use for more than 10 days, and store the device & battery in a dry and safe place.
- Be extra cautious and handle the device with care during use or transportation. It is recommended to use the original packaging during transportation.
- Do not use the device to focus directly on strong sources of light such as the sun or electric welding. The detector may be damaged and it will void the warranty.
- Avoid lens scratches and damage caused by oil or chemical contamination of the lens. Keep the lens cap on when not in use.
- The device should be placed in a cool, dry, and ventilated environment without strong electromagnetic fields, and the storage environment temperature should not be lower than (-30°C/-22°F) or higher than (55°C/131°F).
- Do not disassemble the device without authorization. If you encounter any problems, please contact our after-sales team and report them on our official website. Failure to do so will render the warranty service null and void.
- **Attention!** All PARD night-vision and thermal imaging devices require a license when exported to outside your country.

Package Contents

Icon	Contents	Quantity
	Thermal Imaging Device	1
	3.7V 18650 Rechargeable Lithium-Ion Battery	1
	Protective Case	1
	Type-C Cable	1
	30mm Mount Rings	2
	Allen Wrench	2
	Lens Cleaner	2
	Rubber Eye Cup	1
	User's Manual	1
	After Sales Card	1

Description & Key Features

Step into the world of superior hunting experiences with the Pantera SERIES, a versatile thermal imaging device that seamlessly merges cutting-edge technology with the classic design of a traditional day scope. Equipped with a genuine 800x800 circular screen and PARD's unique LONG EYE-RELIEF Display System, this scope doesn't just offer exceptional optical clarity—it also prioritizes your comfort by minimizing the impact of recoil on your eyes.

Experience enhanced vision like never before with the newly upgraded 480x360/640x480 thermal imaging detector, boasting an NETD \leq 20mK. With brighter images, crisper edges, and enhanced details, spotting your prey becomes effortless. In addition, you can measure how far away your target is, up to 1000m, and the scope helps adjust your aim for a great shot every time thanks to its ballistic calculator. The upgraded thermal imaging scope is made to make your hunting trips better and easier.

Elevate your hunting game with the Pantera SERIES, meticulously designed to enhance your hunting expeditions with unparalleled precision and ease.

Key Features

- Long eye-relief display system (LEDS)
- Ultra-long exit pupil distance display system
- 800*800 IPS circular screen
- Image shift one-shot zeroing
- Ballistic calculation
- 12µm high sensitivity infrared sensor
- Infrared Image Enhancement Algorithm (IREA)
- Intuitive control knob
- 1000m/1200yds LRF
- Recoil-activated recording
- WiFi
- IP67 rating
- 6000J recoil resistance

Specifications

Model	Pantera 480		Pantera 640	
Classification	Thermal Imaging scope			
Sensor				
Type	Uncooled Vox IR Sensor			
Resolution(pixel)	480*360		640*512	
Pixel Size(µm)	12*12		12*12	
NETD	≤20mK(0.020℃)		≤20mK(0.020℃)	
Frame Rate(Hz)	50		50	
Human Detection Distance(m)	1800		2600	
Vehicle Detection Distance(m)	2600		3900	
Image Engine	PARD IREA		PARD IREA	
Objective lens(mm)	35/50		50/75	
Optical Magnification(x)	2.3/3.3		2.5/3.8	
Digital Zoom(x)	2/4/6/8		2/4/6/8	
Field of view(HxV)	Horizontal	7.1°/5°	7°/4.7°	
	Vertical	7.1°/5°	7°/4.7°	
	Diagonal	10°/7°	9.9°/6.6°	
Eye Relief(mm)	100		100	
Diopter Adjustment(D)	-5~+3		-5~+3	

Display	
Type	IPS
Resolution(pixel)	800*800
Reticle Style	6
Reticle Color	4(Red/White/Yellow/Green)
Scene Mode	City/Rain/Forest
Image Mode	WT-HOT/BK-HOT/EDGE/RD-HOT/IN-HOT/SKY
Photo / Video	
Photo Resolution(pixel)	1536*1536
Photo Format	.JPG
Video Resolution(pixel)	768*768
Video Format	.mp4
Storage(GB)	Micro SD card (Max. 128)
Main Function	
LRF Detection Range(yd/m)	1200/1000
PIP	Yes
Gyroscope	Yes
Loop Recording	Yes
Hot track	Yes
E-compass	Yes
Shutter	Mechanical shutter
Microphone	Yes
Firmware Upgrade	Yes
Connections	
USB Type-C	Yes
HDMI Output	Yes
WiFi	Yes
Supported Apps	PardVision2

Power Supply	
Battery type	Li-ion 18650*1
Output Voltage(V)	3.7
Operating Time(h)	≤5
External Power Supply Type	Type-C
Environmental characteristic	
Degree of Protection	IP67
Operating Temp(°C/°F)	-30 ~ +55 / -22 ~ +131
Recoil Resistance(J)	6000
Material	
Housing	Aluminum Alloy
Objective lens	All-glass multi-coated lens

Components

Pantera Series

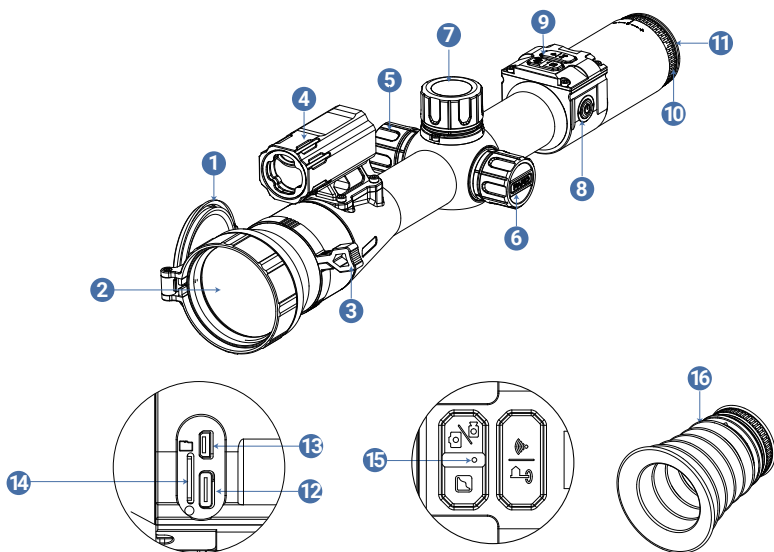

Fig. 1

No.	Name	No.	Name
①	Lens Cap	⑨	Keypad
②	Objective Lens	⑩	Diopter Adjustment Ring
③	Focus Lever	⑪	Eyepiece Lens
④	LRF Module	⑫	Type-C charging Port
⑤	Battery Cap	⑬	HDMI Port
⑥	Battery compartment	⑭	Micro SD Card Slot
⑦	Control knob	⑮	Power Indicator
⑧	Power/Sleep Button	⑯	Rubber Eye Cup

Installation

1. Unboxing

Before using this device, please do the following:

- ① Open the box and remove the device.
- ② Check to ensure that the package contents listed above are all included in the box.
- ③ Check the device for any damage to the display, body, lens, buttons, etc.
- ④ Make sure that the objective lens and eyepiece are clean & functioning properly.

Note: If any accessories are missing or damaged, please contact our after sales service.

2. Battery Installation and Startup

The battery installation steps are as follows:

2.1. Unscrew the battery cap button until it opens and remove the battery.

2.2. Remove the insulating tape.

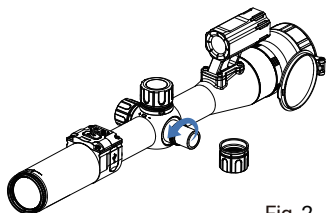

Fig. 2



Fig. 3

2.3. Put the positive pole (+) of the battery inwards, and then screw the battery cap until the battery cap is locked.

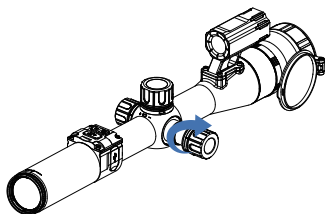

Fig. 4

2.4. To turn on the device, press and hold the power button for about 3 seconds. (When the power light illuminates and the PARD Logo appears on the screen, the device is ready for use.)

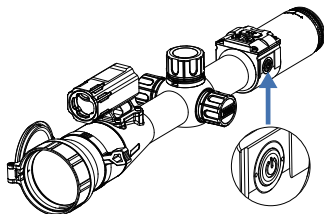

Fig. 5

Note:

- 1 Please use a single 18650 rechargeable lithium-ion battery rated 3.7V voltage.
- 2 Do not expose the battery pack to high temperature or to a naked flame.
- 3 Do not put the device into water when the battery cover is open;
- 4 Do not expose disassemble the device without authorization;
- 5 Do not pierce the device with sharp objects;
- 6 Battery should be kept out of reach of children, and the positive and negative terminals of the battery should be installed correctly;
- 7 Whilst charging the battery do not leave the battery unattended.
- 8 When using the battery at cold(low) temperatures, the battery capacity decreases, this is normal and not a defect.
- 9 Do not use the battery if it has been damaged in any way.
- 10 After charging is complete do not leave the battery on charge connected to the network.



Please act responsibly and recycle or dispose of all used batteries according to the law.

3. Mount Installation

To ensure optimal performance and user experience, we highly recommend using our original mount provided in the product packaging.

- 1 Open the box and take out the thermal imaging scope, 2 mount and 1 Allen wrench;
- 2 Use the Allen wrench to unscrew the ring tops, and loosen the screws on the bottom half of the mount;
- 3 Attach the bottom half of your rings to the rail;
- 4 Tighten the screw on the rear mount to your rail to the desired position;
- 5 Place the scope in the scope rings. The scope should slide with minimum resistance;
- 6 Install the ring tops and tighten down the screws and make sure the scope stays level.

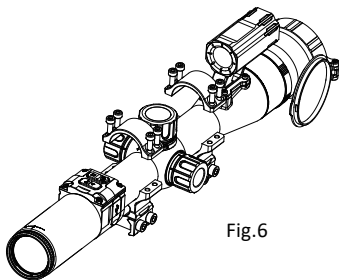

Fig.6

4. Diopter Focusing

Diopter focusing is used to adjust users with different levels of corrected vision to clearly see the content displayed on the screen.

- 1 After power on the device, rotate the diopter focusing wheel until you can see the screen clearly.
- 2 Please note that the image may not be clearly visible before objective lens focus adjusted, only the wording and symbols on the display screen are clearly visible at this stage.

5. Objective Lens Focusing

- 1 Before you focus the objective lens, ensure that the diopter focusing has been completed.
- 2 Aim at the target you want to see, and turn the focus lever of the objective lens until you can see the target image clearly.

6. Compass Calibration

After the eyepiece is focused, please use the "figure 8 pattern method" to calibrate the electronic compass. Users are required to tilt and move the device in a figure 8 motion until the compass is calibrated as shown in Fig. 7.



Fig. 7

7. Zeroing (Retical Adjustment)

Reticle adjustment refers to aligning the reticle with the point of impact at a specific zeroing distance, ensuring that the aiming point corresponds accurately with the point of impact of the bullet.

1. Interface Explanation

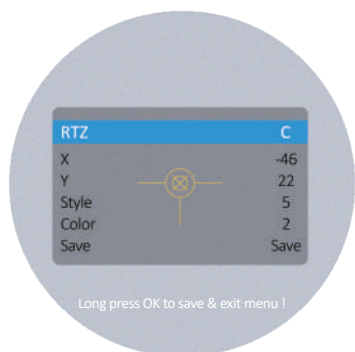

Fig. 8

- The first item in the sub-menu represents the saved "zero" setting, there are five profiles A-E.
- "X" represents the X axis of the cross line.
- "Y" represents the Y axis of the cross line.
- Style corresponds to the crosshair type (6 options available).
- Color corresponds to the color of the cross line (red/white/yellow/green).
- Under the Save option, "Y" means to SAVE, and "N" means DO NOT SAVE.

2. Zeroing steps

- 1 Set the target:** Set the target at the zeroing distance and ensure that the device can obtain a good image.
- 2 Enter to reticle adjustment (Zeroing page):** In the home screen mode, press [Key 1] to enter the shortcut menu mode, and rotate the [knob] counterclockwise to move the cursor to the reticle adjustment setting option. Press [Key 1] to enter the sub-menu interface.



Fig. 9

- 3 **Profile setting:** After entering the zeroing page, rotate "RTZ" items from A-E to create a new zeroing profile or edit an existing one.
- 4 **Shoot:** Fire a 1st shot at the center of the target, ensuring that you can see a clear point of impact on the screen after the shot has been taken.
- 5 **Adjust zero value:** Keep the scope steady after shooting, and then press the [knob] to move the cursor to the "X" and "Y" items. Rotate the [knob] to freeze the screen
- 6 and adjust the values of "X" and "Y" until the reticle center point aligns with the impact point on display.

Save and exit: Rotate [knob] clockwise to set the "Save" item to "Y". Once the setting is completed, press and hold [knob] to save and exit. The actual point of impact will be shifted to the center point of the reticle. (The reticle is always at the center of the screen, which can maximize the use of the whole observation field.)

Note: For the horizontal direction, you can align the center of the reticle with the point of impact by adjusting X value. This will shift the background image and the reticle is always horizontally centered after zeroing. For the vertical direction, you can adjust Y value to move the position of the reticle on the Y axis to align the center of the reticle with the point of impact.

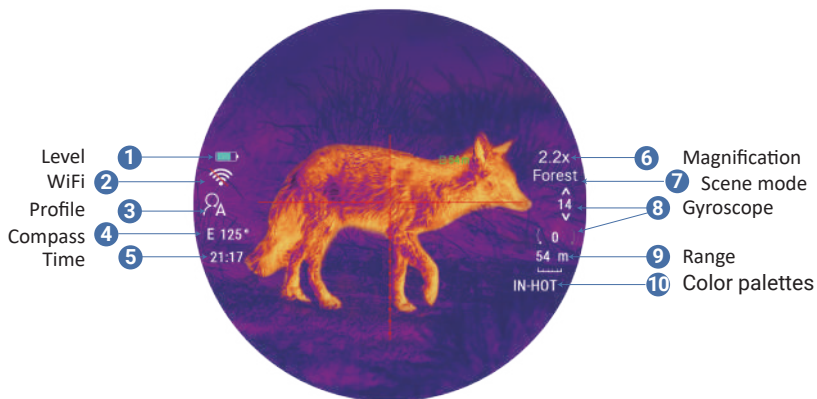

Fig. 10

1. Shortcut Mode

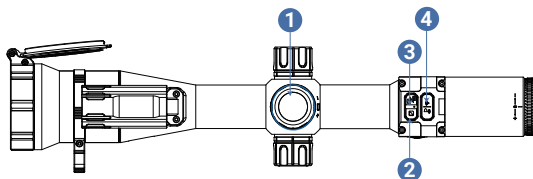

Fig.11

Keypad	Rotate counter clockwise	Rotate clockwise	
Knob (Key1)	Down/-/Zoom out	Up/+ /Zoom	-
	Single press	Press and hold	Double press
	Quick Menu/Ok key	Full Menu	PIP
	Single press	Press and hold	Double press
Key2	Color Palettes	Scene Modes	-
Key3	Take a Photo	Record Video	Files
Key4	LRF/Back	WiFi	Shutter Correction

Explanation

Key 1:

1. Single press:

- ① **Home screen mode:** press [Key 1] to enter the shortcut menu;
- ② **Menu mode:** press [Key 1] means confirm;

2. Press and hold:

Home screen mode: press and hold [Key 1] to enter the full menu;

3. Double press:

Home screen mode: double press [Key 1] to open/close the PIP function;

4. Rotate counterclockwise:

- ① **Home screen mode:** rotate the [knob] counterclockwise to zoom out;
- ② **Menu mode:** rotate the [knob] counterclockwise to scroll down between menu options. In the parameter setting interface under the sub menu, rotate the [knob] counterclockwise to decrease the values;

5. Rotate clockwise:

- ① **Home screen mode:** rotate the [knob] clockwise to zoom in;
- ② **Menu mode:** Rotate the [knob] clockwise in the menu option interface to switch menu options upward. In the parameter setting interface under the sub menu, rotate the [knob] clockwise to increase the values.

Key 2:

1. Single press:

- ① **Home screen mode:** press [Key 2] to switch between image mode: WT-HOT/BK-HOT/EDGE/RD-HOT/IN-HOT/SKY;

2. Press and hold:

- ① **Home screen mode:** press and hold [Key 2] to switch between city/forest/rain scene modes.

Key 3:

1. Single press:

- ① **Home screen mode:** press [Key 3] to take a photo;

2. Press and hold:

- ① **Home screen mode:** press and hold [Key 3] to record a video. Press and hold [Key 3] again to save the video and exit;

3. Double press:

Home screen mode: double press [Key 3] to enable the playback function. After entering this interface, the video and picture files in the memory card will be displayed.

- a) Rotate the [Knob] to switch between files.
- b) Press [Knob] to play/pause the saved videos.
- c) When playing videos, rotate the [Knob] to fast forward or rewind 2x/4x/8x times.
- d) Press [Key 4] to access the following settings:

1) Delete:

- Delete Current
- Delete All

2) File Protection:

- Lock Current
- Unlock Current
- Lock All
- Unlock All

2) Slide Show:

- 2 seconds
- 5 seconds
- 8 seconds

- e) Press [Key 4] again to return to the files interface, then press and hold [Key 4] to return to the home screen.

Key 4:

1. Single press:

① Home screen mode:

- a) Press [Key4] to start the range detection function (For LRF version, the distance will be measured and displayed automatically. For non LRF version, the distance is not measured automatically and will display "[0]m or [0]yds". You need to manually input the target distance value by pressing [Key 1]).
- b) Press [Key 4] a second time to turn on the ballistic indicator (when the ballistic calculator is turned off, the range indicator is turned off);
- c) Press [Key 4] a third time to turn off the ballistic indicator; (when the ballistic calculator is turned on);

② **Menu mode:** press [Key 4] to return to the previous page;

2. Press and hold:

① **Home screen mode:** turn on/off the Wi-Fi function;

Note: When the Wi-Fi is turned on, you cannot access the menu. Press and hold [Key 4] to turn off the Wi-Fi and then enter the menu interface;

3. Double press:

① **Home screen mode:** double press [Key 4] to start the shutter correction function (To use this short cut key function, you must first enable the auto shutter in the menu).

Menu Mode

Home screen mode: press [Key 1] to enter the shortcut menu mode. Press and hold [Key 1] to enter the full menu setting mode to set various function options (the shortcut key function is invalid at this time).

1. Image Setting

Users can adjust the image contrast, brightness, detail, sharpness and mode under this setting.

- ① Rotate the [knob] counterclockwise to move the cursor to the image setting option, press [Key 1] to enter the sub-menu.
- ② Press [Key 1] to switch between contrast/brightness/detail/sharpness/mode options, and rotate the [knob] to adjust the option value.
- ③ Press and hold [Key 1] to exit. Upon the next startup, the device will maintain the saved image settings.

Image default settings: contrast value is 105, brightness value is 60, detail is 5, sharpness is 2 and the mode value is 0.

2. Display Brightness

Users can adjust the display brightness of the screen to adapt to different surroundings.

- Rotate the [knob] counterclockwise to move the cursor to the display brightness option, press [Key 1] to enter the sub-menu.
- Rotate the [knob] to move the cursor to select "level 0"/"level 1"/"level 2"/"level 3"/"level 4"/"level 5"/"level 6" options.
- Press [Key 1] to save and return to the previous page.

3. Ballistic Calculator

The ballistic calculator can calculate bullet trajectories and give you a precise aiming point enabling you to accurately place your shot. The device supports five profiles allowing you to use the scope on multiple rifles.

- ① Home screen mode: press [Key 1] to enter the shortcut menu mode.
- ② Rotate the [knob] to move the cursor to the ballistic calculator setting option, press [Key 1] to enter the sub-menu.
- ③ Rotate the [knob] to move the cursor to select "parameters" or "on/off" and then press [Key 1] to save or enter.
- ④ After entering the ballistic calculator parameters sub-menu, press [Key 1] to scroll up or down to the parameters option you want to change. Rotate the [knob] to adjust the value of the corresponding parameter.

Parameter settings guide:

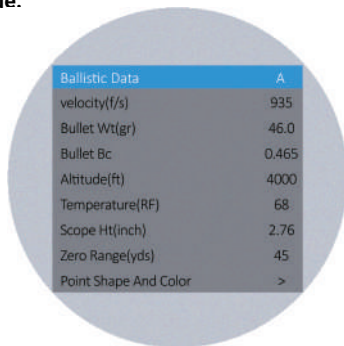

Ballistic Data	A
velocity(f/s)	935
Bullet Wt(gr)	46.0
Bullet Bc	0.465
Altitude(ft)	4000
Temperature(RF)	68
Scope Ht(inch)	2.76
Zero Range(yds)	45
Point Shape And Color	>

Fig. 12

The first step in using ballistic calculator is to fill out the Profile that is being used with all relevant data such as target velocity, bullet weight and zero range.

- **Ballistic Data:** There are 5 sets of ballistic data profiles (A-E) that can be saved.
 - ▶ To create a new profile, rotate the [knob] clockwise to switch from (A-E)
 - ▶ Rotate the [knob] counterclockwise, to go backwards from profile (E-A)
- **Velocity:** is the measurement of bullet travel speed after it is fired from your rifle, expressed in "meters per second" (m/s) or "feet per second" (f/s), which can be measured by using professional testing equipment.
- **Bullet Wt:** refers to the weight of the bullet, expressed in "grams" (g) or "grains" (gr), which can be obtained from the manufacturer's specifications of the bullets purchased.
- **Bullet BC:** refers to bullet ballistic coefficient which is a measure of the bullet's ability to overcome air resistance in flight. Data can be obtained from the manufacturer's specifications of the bullets purchased.
- **Altitude:** refers to the altitude of the location, expressed in "meters" (m) or "feet" (ft), which is one of the important indicators affecting air density in ballistic calculation, which can be measured by using professional testing equipment.
- **Temperature:** refers to the local temperature, expressed in "Celsius" (°C) or "Fahrenheit" (°F), which is also one of the important indicators affecting air density in ballistic calculation, which can be measured by using professional testing equipment.
- **Scope Ht:** refers to the height difference between the optical axis of the sight and the barrel, expressed in "millimeters" (mm) or "inches" (inch), which can be measured by using professional testing equipment.
- **Zero range:** refers to the unit distance expressed in "meter" (m) or "yard" (yard), usually set to 100m or 100yds, users can adjust according to their own preferences.

- **Point Shape and Color:** There are three shape options as well as yellow/green/blue color options to customize the ballistic calculator to suit your personal needs.

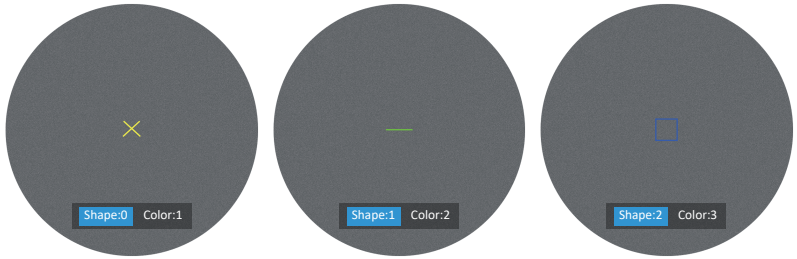

Fig. 13

- ▶ Rotate the [knob] clockwise to enter the shape and color setting interface.
- ▶ Press [Key 1] to switch between shape options and color sub-options.
- ▶ Rotate the [knob] to select the desired shape and color.
- ▶ Press [Key 4] to confirm and return to the previous page.

⑤ After adjusting your preferred settings, press and hold [Key 1] to save and return to the home screen. Press [Key 4] to exit without saving.

Note:

1. By setting the "meter" or "yard" in the range unit selection sub-menu, the metric or imperial units of the parameters related to the ballistic calculator will be updated automatically.
2. If you do not know all or part of this information (for example, bullet weight), we recommend contacting the manufacturer of the ammunition and/or weapon that you are using. In most cases, this information can be found on the manufacturer's specifications of the product purchased.

4. Range Unit Selection

Users can switch between "meter" or "yard" and the range unit can be updated instantly to meet the user's preference.

- Rotate the [knob] counterclockwise to move the cursor range unit selection option, and press [Key 1] to enter the sub-menu.
- Rotate the [knob] to choose between "meter" or "yard", then press [Key 1] to save and return to the previous page.

5. Reticle Adjustment

Reticle Adjustment refers to aligning the reticle with the point of impact at a zeroing distance, so that the position of the aiming point at this specific distance corresponds with the point of impact of the bullet.

- Rotate the [knob] counterclockwise to move the cursor to the reticle adjustment setting option. Press [Key 1] to enter the sub-menu interface.
- Press [Key 1] to switch sub-menu options. Rotate the [knob] to adjust the value of the corresponding item (please see the detailed instructions from above zeroing steps).
- After selecting your preferred settings, there are two saving methods: 1. Set "Yes" under Save option, press the [Knob] to save and exit. 2. No matter whether "Yes" or "No" under Save option, press and hold the [Knob] also means to save and exit.

6. Gyroscope

This function measures the orientation of the device so that the yaw and pitch angles of the device can be displayed and calibrated.

- Rotate the [knob] counterclockwise to move the cursor to the gyroscope setting option, and press [Key 1] to enter the sub-menu.
- Rotate the [knob] to select "Display" or "Calibration", and then press [Key 1] to enter.
- "Display" indicates whether (or not) to display the yaw and pitch angle of the device on the home screen. Rotate the [knob] to select "Off" or "On", and press [Key 1] to save and return to the menu.
- "Calibrate" means to enter the calibration state. After selecting, please place the device on a horizontal plane surface, and press [Key 1] to perform automatic calibration. After calibration, the device will automatically return to the home screen.

7. Scene

There are three built-in scene modes, "City", "Forest" and "Rain". Users can choose any of the available scenes to achieve the best image display effect.

- Rotate the [knob] counterclockwise to move the cursor to the scene option, press [Key 1] to enter the sub-menu.
- Rotate the [knob] to move the cursor to select "City", "Forest" or "Rain" mode. Press [Key 1] to save and return to the previous page.

8. Picture in Picture

The top center of the display can show a 2x magnified picture to improve aiming visibility, allowing you to see magnified target details without losing the field of view.

- Rotate the [knob] counterclockwise to move the cursor to the PIP setting option, and press [Key 1] to enter the sub-menu.
- Rotate the [knob] counterclockwise to move the cursor to select "Off" or "On".
- Press [Key 1] to save and return to the previous page.

9. Hot Track

The device can detect and display the highest temperature point on the screen, and automatically track this target heat source.

- Rotate the [knob] counterclockwise to move the cursor to the hot track setting option, and press [Key 1] to enter the sub-menu.
- Rotate the [knob] to move the cursor to select "Off" or "On". Press [Key 1] to save and return to the previous page.

10. Self-activated Recording

When the device detects recoil, the whole shooting process will be recorded in 20 second intervals. The incremental 20-second video footage will be saved on the Micro SD card.

- Rotate the [knob] counterclockwise to move the cursor to the self-activated recording setting, and press [Key 1] to enter the sub-menu.
- Rotate the [knob] to select "OFF", "ON" and "Impact Sensitivity" options
- After selecting "Off" or "On", press [Key 1] to save and return to the previous page.
- After selecting "Impact Sensitivity", press [Key 1] to enter the sub-option menu of sensitivity level. Rotate the [knob] to select "Off", "Low", "Medium" or "High" mode. Press [Key 1] to save and return to the previous page.

11. Auto Power Off

After selecting your preferred time duration, the device will sense the last point of operation before beginning the shutdown. Auto power off will start after the device has been idle then it automatically triggers the auto power off command.

- Rotate the [knob] counterclockwise to move the cursor to select the auto power off setting, and press [Key 1] to enter the sub-menu.
- Rotate the [knob] to select "Off", "One minute", "Ten minutes" or "Thirty minutes" duration options. After selection, press [Key 1] to confirm and save, and return to the previous page.

12. Auto Recording

After auto recording is on, device will start recording and continue to record after the next startup.

- Rotate the [knob] counterclockwise to move the cursor to the auto recording setting option and press [Key 1] to enter the sub-menu.
- Rotate the [knob] to select "Off" or "On" options, press [Key 1] to save and return to the previous page.

13. Loop Recording

Users can customize the segment recording duration. This can be set up under loop recording. When the capacity of the memory card is full, the new recording will automatically overwrite the previous saved files. When you select "Off", the recording will stop when the memory card is full, and the oldest video file will not be overwritten.

- Rotate the [knob] counterclockwise to move the cursor to the loop recording setting option, and press [Key 1] to enter the sub-menu.
- Rotate the [knob] to move the cursor to select preferred loop time duration "Off", "Three minutes", "Five minutes" or "Ten minutes". Press [Key 1] to save and return to the previous page.

14. Date Stamp

Users can set whether to display the time stamp in the lower right corner of photos and videos taken.

- Rotate the [knob] counterclockwise to move the cursor to the date stamp setting option, and press [Key 1] to enter the sub-menu.
- Rotate the [knob] to move the cursor to select "Off" or "On" options. After selection, press [Key 1] to save and return to the previous page.

15. Record Audio

User can set whether to record audio synchronously in the video.

- Rotate the [knob] counterclockwise to move the cursor to the recording audio setting option, press [Key 1] to enter the sub-menu.
- Rotate the [knob] to move the cursor to select "Off" or "On" option, after selection, press [Key 1] to save and return to the previous page.

16. WiFi

Through the WiFi connection, you can use your phone, PC or tablet as an external viewfinder enabling users to synchronously see the photos and videos on a larger screen.

- Rotate the [knob] counterclockwise to move the cursor to the WiFi setting option, and press [Key 1] to enter the sub-menu.
- Rotate the [knob] to move the cursor to select "On" or "Off" option. Select "Off", and return to the previous page. Select "On" to enable WiFi and return to the home screen.

Steps to connect to your mobile device:

- Download "PardVision2" from the Apple App Store or the Google Play Store.
- Turn on the WiFi on your device and on your mobile device.
- Search the WiFi on your mobile device (the device WiFi network is a string of characters starting with PARD, which is a unique string of numbers). Please enter the password: 12345678 to connect.
- Enter the application to operate and use.

Note: After the WiFi is turned on, you cannot access the menu. Press and hold [Key 4] to disable the WiFi and then enter the menu interface.

17. Language

Users can choose their preferred language.

- Rotate the [knob] counterclockwise to move the cursor to the language setting option, press [Key 1] to enter the sub-menu.
- Rotate the [knob] to move the cursor to select the desired language. Press [Key 1] to switch the system language and return to the previous page.

18. ICON Display

Users can choose the display of icons on or off on the screen.

- Rotate the [knob] counterclockwise to move the cursor to the Icon Display option, press [Key 1] to enter the sub-menu.
- Rotate the [knob] to move the cursor to select the Icon Display duration "On", "30 second", "1 minutes", "3 minutes", "5 minutes" or "10 minutes". Press [Key 1] to save and return to the previous page.

19. Date/Time

Users can set the system date and time of the device.

- Rotate the [knob] counterclockwise to move the cursor to the date/time setting option, press [Key 1] to enter the sub-menu.
- Rotate the [knob] to adjust the setting date and time value, press [Key 1] to switch options, press [Key 4] to save and return to the previous page.

20. Format

If users want to reformat the Micro SD Card, it will delete all the data on the Micro SD card permanently. Data cannot be recovered after reformatting. **Please operate with caution!**

- Rotate the [knob] counterclockwise to move the cursor to the format setting option, and press [Key 1] to enter the sub-menu.
- Rotate the [knob] to move the cursor to select "Cancel" or "OK" option. After selection, press [Key 1] to confirm the relevant operation and return to the previous page.

21. Blind Pixel Compensation

The blind pixel compensation algorithm enables effective compensation for blind spots that no longer respond to light and also reduces image distortion.

- Rotate the [knob] counterclockwise to move the cursor to the blind pixel compensation option, press [Key 1] to enter. You will see an important reminder:
 - ① Please put on lens cap;
Long press the menu key to execute;
Short press the ranging key to exit;
Press [Key 4] to exit. Press and hold [Key 1] to start the blind pixel compensation.
- After the process is completed, you can rotate the [knob] to move the cursor to backup: "Yes" or "NO".

22. Default Settings

If users decide to reset the device, it will restore the device to the factory default settings and all of the user data and personalized settings will be deleted. Please operate with caution!

- Rotate the [knob] counterclockwise to move the cursor to restore default setting option, press [Key 1] to enter the sub-menu.
- Rotate the [knob] to move the cursor to select "Cancel" or "OK" option. After selection, press [Key 1] to confirm the relevant operation and return to the previous page.

23. Firmware Upgrade

System firmware can be updated to maintain an optimized current version.

- Rotate the [knob] counterclockwise to move the cursor to the firmware upgrade option, and press [Key 1] to enter the sub-menu. You will see an important reminder: Upgrading firmware may cause damage to the equipment, please operate with caution!

- Press and hold [Key 1] to confirm and short press [Key 4] to exit and return to the previous page.

Note: When performing this operation, please load the device with a fully charged battery and type-C power supply. Powering off the device during the firmware update process may cause damage to the device components. Please operate with caution.

24. Version

This function displays the device's version.

- Rotate the [knob] counterclockwise to move the cursor to the version option, press [Key 1] to enter the sub-menu to view.
- Press [Key 1] again to exit and return to the previous page.

This device complies with part 15 of the FCC Rules. Operation is subject to the following two conditions:

- (1) This device may not cause harmful interference, and
- (2) This device must accept any interference received, including interference that may cause undesired operation.

Note: This equipment has been tested and found to comply with the limits for a Class B digital device, pursuant to part 15 of the FCC Rules. These limits are designed to provide reasonable protection against harmful interference in a residential installation. This equipment generates, uses and can radiate radio frequency energy and, if not installed and used in accordance with the instructions, may cause harmful interference to radio communications. However, there is no guarantee that interference will not occur in a particular installation. If this equipment does cause harmful interference to radio or television reception, which can be determined by turning the equipment off and on, the user is encouraged to try to correct the interference by one or more of the following measures:

- Reorient or relocate the receiving antenna.
- Increase the separation between the equipment and receiver.
- Connect the equipment into an outlet on a circuit different from that to which the receiver is connected.
- Consult the dealer or an experienced radio/TV technician for help.

Note: The Grantee is not responsible for any changes or modifications not expressly approved by the party responsible for compliance. Such modifications could void the user's authority to operate the equipment. The device has been evaluated to meet general RF exposure requirement. This equipment complies with FCC's RF radiation exposure limits set forth for an uncontrolled environment. This device and its antenna(s) must not be co-located or conjunction with any other antenna or transmitter.

Follow Us



@pardtechnology



@pard.europe



@Pardvision



Please Search and follow our channel for more information

Website

www.pard.com

Business Cooperation

info@pard.com

Service Center

support@pard-tech.com

CE  FC RoHS